



# **Hamco Premium Auto-Fill Pet Water Dispenser With Installation Kit**

For Indoor / Outdoor / Pet House ...Use

## **AF-220**

### **Instruction Manual**



Please read this manual before use

# Contents

<b>Overview</b>	<b>03</b>
<b>Important Safety Instruction</b>	<b>04</b>
<b>Product Introduction</b>	<b>06</b>
<b>Product Installation Steps</b>	<b>08</b>
<b>Maintenance and Cleaning</b>	<b>11</b>

## Overview

Thank you for purchasing the “Hamco Premium AF220 Automatic Fill Pet Water Dispenser”.

- AF220 can be fixed on the indoor, outdoor wall or dog house..., so that your pet can have fresh and clean water to drink anytime and anywhere.
- AF 220 with sealing design prevents dust from entering, the water will not pollute.
- AF220 has an upgrade version filtered cartridge set, each set contains:
  1. Natural Coconut Shell Activated Carbon x1 bag: Effectively remove chlorine and eliminate odor.
  2. Sodium-free ion exchange resin x 1 bag: Can soften tap water quality, reduce heavy metals and provide fresh and clean water for pets.
- AF220 has safe and reliable automatic water filler that can automatically replenish water into the water dispenser at any time. You don't worry about running out of water for your pet.
- All parts of AF220 are made of NSF or FDA food grade materials to ensure that pet drinking water is not contaminated.
- Hamco AF series can be connected together to give each pet its own Water Dispenser and maintain your pets' health.

## Important Safety Instruction

1. Before using it, please ensure that you have checked and installed all the parts and accessories of the AF220. **(Refer to the 'Product Installation Steps' as shown.)** This will help prevent issues like water leakage, insufficient water levels, and overflow during automatic refilling, or operational failures etc.
2. Only qualified tap water sources can be used and the water storage equipment (water towers...) in residential buildings must be cleaned regularly every 6-12 months and there is no risk of contamination.
3. In the event of windstorms, floods or other special circumstances, when the competent authority instructs that tap water must be boiled before drinking, or if your pet is immunocompromised, it is recommended not to connect the tap water source. It must be boil the tap water before pouring it into the drinking fountain for your pet to drink.
4. Please clean the drinking dispenser with water regularly and replace the filter cartridge set every 2 weeks to provide clean drinking water for your pets.
5. To prevent cross-infections and maintain your pets' health, it is recommended that each pet has its own water dispenser.

## Important Safety Instruction

6. AF220 come with a 1/2-inch Female threaded connector. If your faucet is without a 1/2-inch Male threaded connector, please purchase an adaptor that can connect to a 1/2-inch female threaded connector before connecting to the faucet and AF220
7. When using this device, please keep the faucet turn on (about half of the water output is enough), and, it will automatically refill into the water tank at any time. You don't worry about running out of water for your pet. It will automatically stop replenishing water when the water level is full.
8. Before using the filter cartridge, please rinse it with water and soak it in water for 5-10 minutes.
9. AF220 quick connector has a water-stop function. When cleaning, you only need to pull out the quick connector from the dispenser lid without turning off the faucet.
10. Ensure that the "automatic water filler" is securely pressed into the water dispenser lid, as it may cause insufficient water level or overflow during the water replenishment process. **(Refer to "Product Installation Steps" Step1.)**
11. Please use the food grade installation kit provided by HAMCO to connect the faucet. Do not use non-food grade water tubes such as garden hose..., as it will lead to water pollution.

# Product Introduction

## 01.Product Diagram

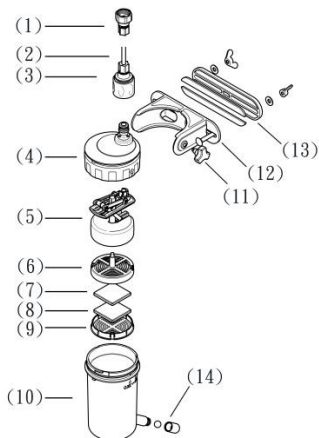



- (01) 1/2 inch Female threaded Faucet connector
- (02) NSF LLDPE tube 10 meter length
- (03) Water-stop quick connector
- (04) Water dispenser lid
- (05) Automatic water filler
- (06) Filter housing upper cover
- (07) Coconut Shell Activated Carbon x 1bag
- (08) Sodium-free Ion Exchange Resin x 1bag
- (09) Filter housing
- (10) Water bottle
- (11) Fixing screw of water dispenser
- (12) Water dispenser holder
- (13) Fixed base of pet's house
- (14) Stainless steel #316 outlet pipe

## 02. Included Accessories



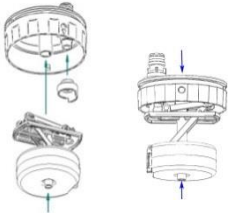

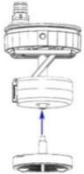
- AF-220
- User Manual
- Water-stop quick Connector x1
- Filter cartridge x Total 3-pack  
Each set Contains:  
Sodium-free Ion Exchange Resin x1 bag  
Coconut Shell Activated Carbon x1 bag
- Installation Kit x 1set  
(NSF 1/4 Inch LLDPE Tube x 10meter length,  
1/2-inch Female threaded connector x1,  
Tube Quick Fitting Tees x 1,  
Tube clamp set x 5pcs)

## Product Installation Steps

Step 1	Step 2-1
	
<p><b>1.</b> Insert the water shield. <b>2.</b> Insert the "automatic water filler" with tightly the dispenser lid together.</p>	<p>First, rinse 1bag the active carbon and 1bag the resin with water and soak them in water for about 5 minutes.</p>
Step 2-2	Step 3
	
<p>Place cleaned 1bag activated carbon and 1 bag the resin into the filter housing and lock it.</p>	<p>Insert the filtered housing into the "automatic water filler".</p>

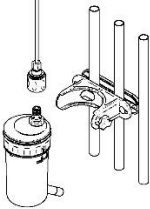

## Product Installation Steps

Step 4	Step 5
	
<p>Press the water dispenser top lid and the water bottle tightly and rotate to lock.</p>	<p>Insert the LLDPE tube and lock it with the quick connector together.</p>
Step 6	Step 7
	
<p><b>1.</b> Lock the fixed holder on the pet's house. <b>2.</b> Insert the AF220 into the fixed holder and lock it. <b>3.</b> Connect the quick connector.</p>	<p>Lock "1/2-inch female threaded connector" into the faucet, and then turn on the faucet.</p>

## Product Installation Steps

### Step 8



Please keep the faucet turned ON. It will automatically fill into the water dispenser when the water level drops.

### Step 9

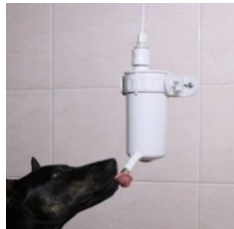



Fix the AF220 on the wall indoors, in the courtyard or outside...Let pets have water to drink anytime and anywhere.

### Step 10



Connect several Hamco AF series for each pet's own water dispenser supply anywhere.

## How to assemble a quick fitting tees and Tubes

Step 1	Step 2	Step 3
		
Insert the LLDPE tube to the bottom of the quick fitting union tee.	Attach C-clip to prevent the Tube from falling out.	Assembly completed.

## Maintenance and Cleaning

Regular cleaning of the AF220 is important to extend its service life. We recommend regular cleaning of the water dispenser with water and replacing of the filter cartridge set every 2 weeks to provide your pets with fresh and clean drinking water.

### How to clean the water dispenser steps

**Step 1:** Remove the quick connector.

**Step 2:** Unscrew the fixing screw of water dispenser by counterclockwise.

**Step 3:** Unscrew the lid of the water dispenser by counterclockwise.

## How to clean the water dispenser steps

**Step 4:** Remove all spare parts, rinse with water and clean with a small brush as shown below.

**Step 5:** After cleaning, please follow the product installation steps to assemble.

(Refer to "Product Installation Steps" for assembly instruction as shown in the picture.)



### Please note:

- X** Do not disassemble any part of the automatic water filler device.
- X** Do not remove the water stop plug of the automatic water filler device.

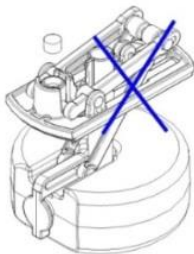



**HAMCO Manufacturing Company**

Address: No.572, SuiYuanRd, Chuan Yao Li,  
Chang Hua City 50070, Taiwan

<https://www.hamcomfg.com>

07.2024