



# Hamco Super Pure Auto-Fill Pet Water Fountain With Installation Kit

Only for Indoor Use

## AF-210 AF-215

## Instruction Manual



Please read this manual before use

# Contents

<b>Overview</b>	<b>03</b>
<b>Important Safety Instruction</b>	<b>04</b>
<b>Product Introduction</b>	<b>07</b>
<b>Product Installation Steps</b>	<b>09</b>
<b>Maintenance and Cleaning</b>	<b>13</b>

## Overview

Thank you for purchasing the "Hamco Super Pure AF210 /AF215 Automatic Fill Pet Water Fountain"

- AF210 / AF215 is for indoor use only. It is not recommended for outdoor use as outdoor dust can easily cause water pollution.
- AF210/AF215 has a Super Pure 5u pp melt-blown filter cartridge and an upgraded version multi-layer filter cartridge set.
  - A).** 5u pp melt blown filter: Can filter out any impurities above 5u in tap water...
  - B).** Upgraded version multi-layer filter cartridge set, each set contains:
    - 1.** High-density filter cotton x 1pcs: can filter pet hair and sediment.
    - 2.** Natural Coconut Shell Activated Carbon x 2 bags: Effectively remove chlorine and eliminate odor.
    - 3.** Sodium-free ion exchange resin x 2 bags: Can soften tap water quality, reduce heavy metals and provide fresh and clean water for pets.
- AF210 / AF215 have safe and reliable automatic water filler that can automatically replenish water into the water tank at any time. You don't worry about running out of water for your pet.
- All parts of AF210 / AF215 are made of NSF or FDA food grade materials to ensure that pet drinking water is not contaminated.
- Hamco AF series can be connected together to give each pet its own fountain and maintain your pets' health.

## Important Safety Instruction

1. Before using it, please ensure that you have checked and installed all the parts and accessories of the AF210 / AF215. **(Refer to the 'Product Installation Steps' as shown.)** This will help prevent issues like water leakage, insufficient water levels, and overflow during automatic refilling, or operational failures etc.
2. Before plug in the power, please make sure that both your hands and the plug are dry to prevent electric shock.
3. Before cleaning or replacing the filter cartridge, the power supply and quick connectors should be disconnected.
4. The power adapter and USB plug must not be flooded during cleaning.
5. Only qualified tap water sources can be used and the water storage equipment (water towers...) in residential buildings must be cleaned regularly every 6-12 months and there is no risk of contamination.
6. In the event of windstorms, floods or other special circumstances, when the competent authority instructs that tap water must be boiled before drinking, or if your pet is immunocompromised, it is recommended not to connect the tap water source. It must be boil the tap water before pouring it into the drinking fountain for your pet to drink.

## **Important Safety Instruction**

- 7.** Please use indoors only. Clean and maintain it, regularly, and replace the filter cartridges set every 2 weeks to ensure the smooth operation of the fountain and provide clean drinking for your pets.
- 8.** To prevent cross-infections and maintain your pets' health, it is recommended that each pet has its own water fountain.
- 9.** AF210 / AF215 come with a 1/2-inch Female threaded connector. If your faucet is without a 1/2-inch Male threaded connector, please purchase an adaptor that can connect to a 1/2-inch female threaded connector before connecting to the faucet and AF210 / AF215
- 10.** When using this device, please keep the faucet turn on (about half of the water output is enough), and, it will automatically refill into the water tank at any time. You don't worry about running out of water for your pet. It will automatically stop replenishing water when the water level is full.
- 11.** Before using the filter cartridge, please rinse it with water and soak it in water for 5-10 minutes.
- 12.** After completing the entire assembly, then turn on the faucet. Allow the faucet water to fill the tank until the water level reaches to flood the pump, which will take about 5-10 minutes. Then, plug in the USB power supply.
- 13.** AF210 / AF215 quick connectors have a water-stop function. When cleaning, you only need to pull out the quick connector from the fountain lid without turning off the faucet.

## Important Safety Instruction

14. When replacing the meltblown filter cartridge of the quick connector, the faucet needs to be turned off.
15. Place the product on a flat surface when the equipment is being used.
16. The USB cable clip should be fixed in the recess of the water tank wall. Do not move the position of the USB cable clamp (too long USB cable inside the tank will interfere with the operation of the automatic water filler and prevent it from refilling or water overflowing). **(Refer to “Product Installation Steps” Step1).**
17. Ensure that the "automatic water filler" is securely pressed into the fountain lid, as it may cause insufficient water level or overflow during the water replenishment process. **( Refer to “Product Installation Steps” Step3 )**
18. Ensure that the Fountain lid and the tank are securely fixed together. If they are not tightly connected, it may lead to water overflow during the water replenishment process. **( Refer to “Product Installation Steps” Step5 as shown)**
19. Please use the food grade installation kit provided by HAMCO to connect the faucet. Don't use non-food grade water tubes such as garden hose..., as it will lead to water pollution.

# Product Introduction

## 01. Product Diagram

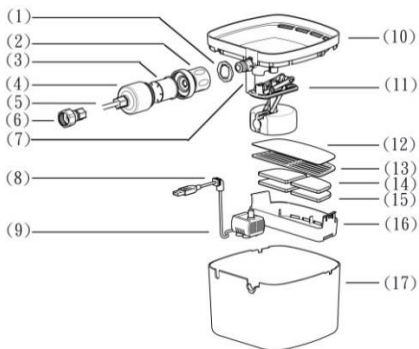

- (01) Safety lock ring
- (02) Super pure water-stop quick connector
- (03) 5u pp meltblown filter cartridge
- (04) NSF housing of meltblown filter cartridge
- (05) NSF LLDPE tube 10 meter length
- (06) 1/2 inch Female threaded Faucet connector
- (07) Pump's water tube
- (08) USB cable holder
- (09) Water Pump with 2 meter USB cable
- (10) Fontain Lid
- (11) Automatic water filler
- (12) High-density filter cotton
- (13) Filter Shelf
- (14) Coconut Shell Activated Carbon x 2 bags
- (15) Sodium-free Ion Exchange Resin x 2 bags
- (16) Filter Box
- (17) Water Tank





## 02. Included Accessories

- AF-210 / AF-215
- User Manual
- Super Pure Water-stop quick connector x 1
- Melt-blown filter cartridge x 3-pack  
Filter cartridge set x Total 3-pack  
Each set contains:
  1. High Density Filter Cotton x 1 pcs
  2. Sodium-free Ion Exchange Resin x 2 bags
  3. Natural Coconut Shell Activated Carbon x 2 bags
- Installation Kit x 1set  
(NSF 1/4 Inch LLDPE Tube x 10meter length,  
1/2-inch Female threaded connector x1,  
Tube Quick Fitting Tees x 1,  
Tube clamp set x 5pcs)





\*Note: 5V1A Adapter is NOT Included.\*







## Product Installation Steps

Step1	Step 2-1
	
<p>Install the pump ,fixed USB cable clip.</p>	<p>Rinse 2 bags the active carbon and 2 bags he resin with water and soak them in water for about 5 minutes.</p>
Step 2-2.	Step 2-3
	
<p><b>1.</b>Put cleaned 2 bags Active carbon and 2 bags Resin into the filter box. <b>2.</b>Then, put the plastic filter shelf. <b>3.</b> Final, put the high-density filter cotton</p>	<p>Fix the filter cartridge box in the tank</p>

## Product Installation Steps

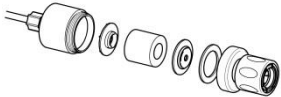
Step 3	Step 4
	
<p>Insert "Auto-Water Filler" into the fountain lid and press it tightly.</p>	<p>Insert the pump's water tube into the fountain lid</p>
Step 5	Step 6
	
<p>Press and fix the installed fountain lid onto the water tank and press it tightly.</p>	<p>Lock "lock ring" to prevent pets opening and water leaking out.</p>



## Product Installation Steps

Step 7-1	Step 7-2
	
<p><b>1.</b> Place the meltblown filter cartridge into the housing <b>2.</b> Place the silicone gasket into the quick connector. <b>3.</b> Lock the quick connector with the housing tightly.</p>	<p>Insert the LLDPE tube and lock it with the super pure quick connector together</p>
Step 8	Step 9
	
<p>Connect the super pure quick connector onto the adapter of the lid.</p>	<p>Lock "1/2-inch female threaded connector" into the faucet. Turn on the faucet, wait for about 5-10 min until the water level exceed PUMP, then plug in the USB power.</p>

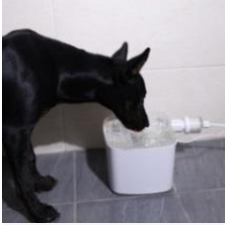
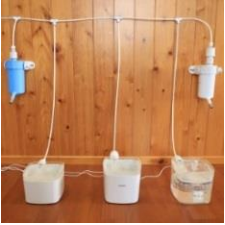
## Product Installation Steps

Step 10	Step 11
	
<p>Keep the faucet turned ON. It will automatically fill into the water tank when the water level drops.</p>	<p>Connect several Hamco AF series for each pet's own water fountain supply anywhere.</p>

## How to assemble a quick fitting tees and Tubes.

Step 1	Step 2	Step 3
		
<p>Insert the LLDPE tube to the bottom of the quick fitting union tee.</p>	<p>Attach C-clip to prevent the Tube from falling out.</p>	<p>Assembly completed.</p>

## Maintenance and Cleaning

Regular cleaning of the AF210 / AF215 and the pump is important to extend its service life. We recommend regular cleaning of the pet fountain with water and replacing of all the filter cartridge sets every 2 weeks to prevent dirt from blocking the waterway. Clogged waterways can lead to poor water flow, reduced water quality, noise, and other abnormalities.

### How to disassemble and replace the melt-blown filter cartridge steps

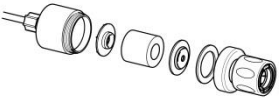
Step 1	Step 2
	
Turn off the faucet and loosen the quick connector.	Unscrew the house of melt-blown filter cartridge.

## How to clean the water fountain steps

**Step 1:** Turn off the power and unplug the USB power supply.

**Step 2:** Remove the quick connector.

**Step 3:** Unscrew the lock ring counterclockwise and open the fountain top lid.

**Step 4:** Remove all parts and rinse with water and clean with a small brush as shown in the picture.

**Step 5:** After cleaning, please follow the product installation steps to assemble. (**Refer to "Product Installation Steps"** for assembly instructions as shown in the picture.)

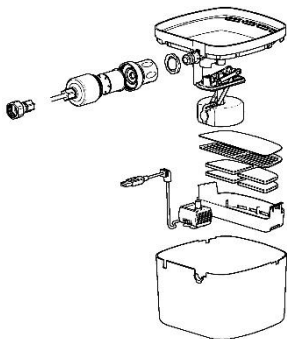

## How to clean the water fountain steps

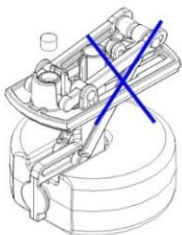

### Please note:

**X** Do not disassemble any part of the automatic water filler device.

**X** Do not remove the water stop plug of the automatic water filler device.

## How to disassemble and clean the Pump

**Step 1:** Open the pump cover

**Step 2:** Remove all parts with water wash and clean them with a brush.

**Step 3:** Assemble the pump after cleaning as follows order as shown

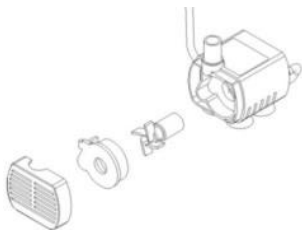



**HAMCO Manufacturing Company**

Address: No.572, SuiYuanRd, Chuan Yao Li,  
Chang Hua City 50070, Taiwan

<https://www.hamcomfg.com>

07.0204